



**Modular Cooking Range Line
900XP Town Gas PowerGrill Top
HP 1200mm**

ITEM # _____

MODEL # _____

NAME # _____

SIS # _____

AIA # _____



391188 (E9GRTLGC0P)

Large gas PowerGrill Top - town gas

Short Form Specification

Item No. _____

To be used with Town gas. High efficiency 11 kW stainless steel burners with self stabilizing flame. Cooking surface grids in enameled cast iron, easily removable for cleaning. Stainless steel AISI 441 deflective shields below radiants avoid burner clogging (Patent Pending). Includes drip tray for the collection of grease and fat. Side and rear panels of unit in AISI 304 stainless steel with Scotch Brite finish. Extra strength work top in heavy duty 2 mm AISI 304 stainless steel. Right-angled side edges to allow flush-fitting junction between units.

Main Features

- Stainless steel AISI441 burners with self stabilizing flame.
- Burners are protected by AISI441 stainless steel deflector reaching approx. 700°C; top and side radiant plates distribute evenly the heating power while protecting the deflector from direct contact with the dripping fat, thus reducing flare ups (PATENT US9591947B2 and related family).
- Cooking grid reaching temperatures up to 350°C.
- Full-depth grease collection drawer, with hole to indicate when full, to collect residual cooking grease and fat. Can be filled-up with water for vapor-emission effect.
- Stainless-steel removable splash guards on the rear and sides
- The special design of the control knob system guarantees against water infiltration.
- All components (deflector, radiant plates, cooking grids, splash guards) can be dismantled for cleaning purposes.
- Cooking grids made in highly resistant enameled cast iron for easy cleaning.
- Suitable for countertop installation.

Construction

- Unit is 930 mm deep to give a larger working surface area.
- All exterior panels in Stainless Steel with Scotch Brite finishing.
- AISI 304 stainless steel worktop, 2mm thick.
- Model has right-angled side edges to allow flush fitting joints between units, eliminating gaps and possible dirt traps.
- All the functional components are accessible via the front of the appliance.
- Side and rear panel in AISI 304 stainless steel.

Optional Accessories

- Junction sealing kit PNC 206086
- Draught diverter, 150 mm diameter PNC 206132
- Support for bridge type installation, 1200mm PNC 206139
- Support for bridge type installation, 1400mm PNC 206140
- Support for bridge type installation, 1600mm PNC 206141
- Scraper kit with hooks for HP grills PNC 206347
- Side handrail-right/left hand (900XP) PNC 216044
- Frontal handrail, 1200mm PNC 216049

APPROVAL: _____





Electrolux
PROFESSIONAL

**Modular Cooking Range Line
900XP Town Gas PowerGrill Top HP
1200mm**

- Frontal handrail, 1600mm

PNC 216050



**Modular Cooking Range Line
900XP Town Gas PowerGrill Top HP 1200mm**

The company reserves the right to make modifications to the products without prior notice. All information correct at time of printing.

2024.04.23

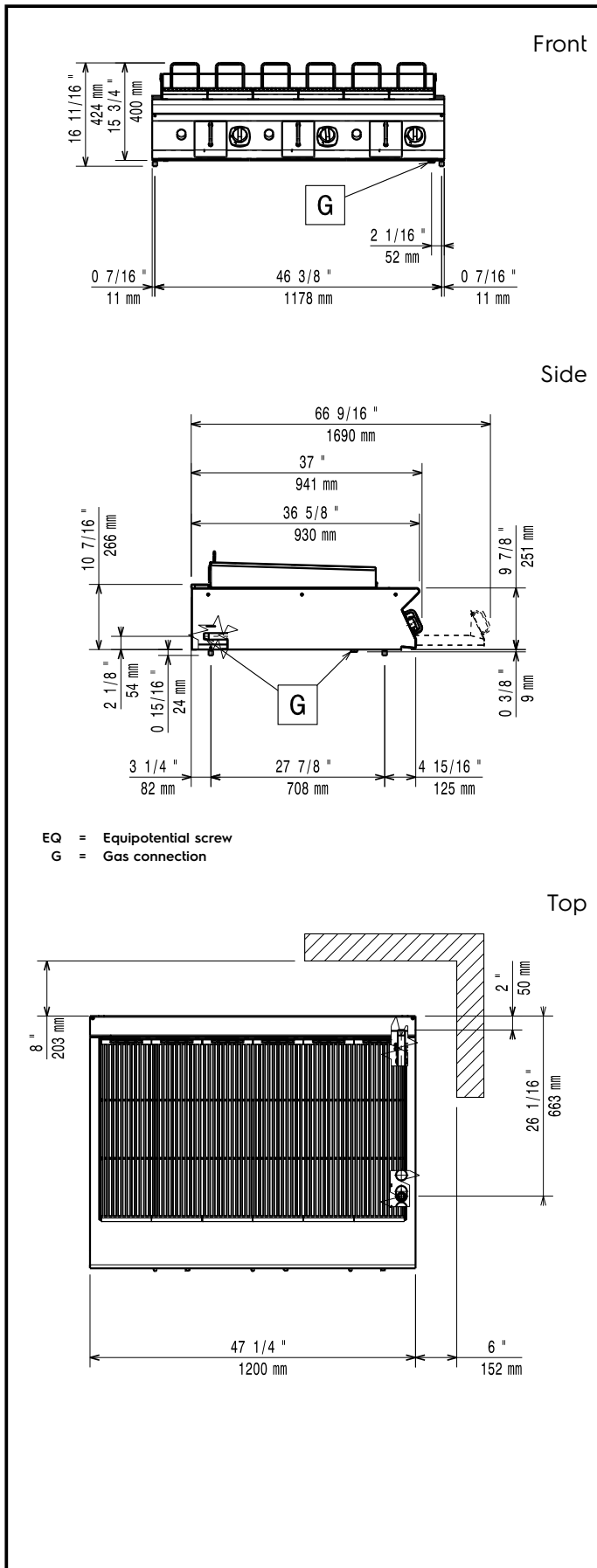

Gas

Gas Power:	
391188 (E9GRTLGC0P)	30 kW
Standard gas delivery:	Town Gas
Gas Type Option:	
Gas Inlet:	3/4"

Key Information:

Cooking surface width:	1113 mm
Cooking surface depth:	644 mm
External dimensions, Width:	1200 mm
External dimensions, Depth:	930 mm
External dimensions, Height:	250 mm
Net weight:	141 kg
Shipping weight:	166 kg
Shipping height:	540 mm
Shipping width:	1400 mm
Shipping depth:	900 mm
Shipping volume:	0.68 m ³
Certification group:	N9EGG

If appliance is set up or next to or against temperature sensitive furniture or similar, a safety gap of approximately 150 mm should be maintained or some form of heat insulation fitted.